 ENGINEERING PRACTICES	ORIGINAL ISSUE DATE 11/14/2019	NUMBER 2031	
	REVISED DATE na		
TITLE TRACK MONITORING FOR WORK DISTURBING ROADBED	RECOMMENDED <i>Evan Whiting</i>	DATE 9/11/19	PAGE 1 OF 12
	APPROVED <i>Steve Hames</i>	DATE 11/14/19	

1. GENERAL

1.1. Introduction and Purpose

Track monitoring is a method of ensuring the integrity of track geometry during construction work that could affect track stability, called Roadbed Disturbing Work. This includes any earth disturbing construction activity either under the track (called underground crossing work) or within 50 feet of the centerline of the nearest track effecting the theoretical railroad embankment line as shown on Figure 1 (called parallel work).

Examples of the types of projects in which track monitoring is required:

- Underground pipe crossings by jacking or horizontal directional drilling
- Local work, such as for foundation excavation or ground dewatering.
- Excavation that is parallel to the track, such as construction of ditch or utility trench.
- Pile driving adjacent to the track, such as construction of an access road.

The purpose of track monitoring is to record railroad track geometry data before, during, and after the completion of construction. The collected geometry data is compared to determine if the track has been adversely affected by construction. If the track has been adversely affected, the data can be used to alert Amtrak personnel to take appropriate action and reestablish pre-construction conditions.

1.2. Related Documents

Amtrak Structures EP 3005 – Pipeline Occupancy

Amtrak Structures EP 3005, Spec. 02082A - Additional Requirements for Horizontal Directional Drilling (HDD) / Directional Boring

Amtrak Track Department Frac-Out Contingency Plan (FCP) (included in Structures EP 3005, Spec. 02082A)

Amtrak Structures EP 3014, Spec. 02261 - Requirements for Temporary Sheeting and Shoring to Support Amtrak Tracks

Amtrak Land Surveying Standards and Procedures Manual, Version 2.0

1.3. Responsibilities

Contractor responsibilities:

- Using proven surveying methods and materials to establish Remote Monitoring Points (RMPs) for collection of track data.
- Gathering and recording track data before construction starts.

TITLE TRACK MONITORING FOR WORK DISTURBING ROADBED	ORIGINAL ISSUE DATE 11/14/2019	NUMBER 2031
	REVISED DATE na	PAGE 2 OF 12

- Gather, recording, and report track geometry data at pre-determined time intervals during construction.
- Comparing pre-construction and during-construction data to determine if differential movement has occurred.
- Report track monitoring data and comparison to Amtrak Construction Project Manager, Assistant Division Engineer of Track, and System Track Contracting Office Technical Representative (COTR).
- Pay for any repairs required if track movement meets or exceeds 3/8-inch in any direction or creates conditions exceeding track geometry maintenance limits as defined in the MW1000 for the class of track concerned.

Amtrak responsibilities:

- Amtrak will identify and provide contact information for the following: System Track COTR for track monitoring, the Assistant Division Engineer of Track responsible for maintenance, and the Construction Project Manager.
- Prior to construction Amtrak will review/approve the submitted Track Monitoring Plan.
- Schedule Track Inspector to cover the anticipated duration of roadbed disturbing work.
- Monitor track movement and prescribe repairs, restrictions, or removal tracks from service to ensure the safety of train operations.

2. METHODS & MATERIALS

2.1. Surveying Requirements

Surveyor in charge of performing track monitoring must be working under the direct supervision of a professional land surveyor duly registered in the state. Contract Surveyors must have working knowledge of Amtrak Survey Specification and have current Contractor Orientation Training credentials.

Datum and accuracy will be in accordance with Amtrak Land Surveying Standards and Procedures Manual, Version 2.0:

Datums – NAD 83 with appropriate UTM Zone - NAVD 88

All coordinates in US survey feet.

Horizontal and vertical accuracy 0.01-feet (1/8-inch) for all reports.

Control must be verified before and during construction with frequency sufficiency to ensure continued accuracy.

2.2. Equipment Requirements

Monitoring shall be performed by a total station instrument having a minimum angular accuracy of 1-second and an electronic distance measurement accuracy of 1.0mm + 2ppm. Total station will locate Remote Monitoring Points (RMPs) located on the track to be monitored.

TITLE TRACK MONITORING FOR WORK DISTURBING ROADBED	ORIGINAL ISSUE DATE 11/14/2019	NUMBER 2031
	REVISED DATE na	PAGE 3 OF 12

Points should be either commercially available calibrated reflective targets or small prisms. All targets shall be mounted a uniform elevation below top of rail.

- Reflective targets shall be less than 3-inches square and affixed by adhesive to the web of the rail (as shown). Common types are shown in figure 1 but are not exclusive. Minimum angle of 30° from instrument to target face is allowed. Therefore, multiple target types may be used to aid in visibility from the instrument. During application the rail should be spot cleaned and dried to allow good adhesion.
- Small precise prisms shall remain at least 1-inch below the top of rail. They are typically on a bracket clamped to the base of the rail and must not interfere with track components.

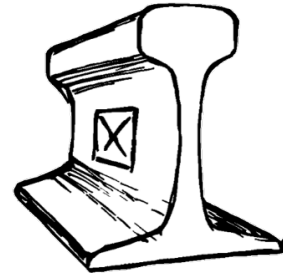

3. MONITORING POINT LOCATIONS

3.1. General Instructions

Benchmarks to be occupied including foresights and back sights, shall be outside of the ZOI for the roadbed disturbing work.

RMPs will be installed as pairs, with one target on each rail of the track to be monitored. The pairs shall be set perpendicular to the direction of the rails to allow for measurement of cross-level.

Pairs of RMPs will be spaced along the rails at 15.5-foot intervals. In locations of special track work (i.e.-turnouts, crossings, and miter rails) the System Track COTR will determine an alternate arrangement.

3.2. Underground Crossing Work

This method for RMPs is applicable for underground work that enters Zone 3 shown on Figure 2 and/or crosses under the tracks.

Determine the Zone of Influence for the underground crossing work at the elevation of the bottom of railroad tie. Calculate by taking the diameter or width of the underground work, extending to the ground surface at the soil angle of repose. Soil angle of repose should be taken from soil borings performed at the crossing location that cover the depth from track level to the depth of underground work. If soil boring data is not available or does not satisfy the System Track COTR, use 20° as a conservative soil angle of repose. See Figure 2 for an example.

In each direction starting from the intersection of the centerlines of underground work and track, place RMPs every 15.5-feet until the monitoring point pairs are outside the Zone of Influence. Continue the RMPs for five pairs outside of the ZOI for a tie-in with undisturbed track. Refer to Figure 3 for an example.

3.3. Work Parallel to Track

This method for placing RMPs is applicable for underground work that enters either Zone 2 or Zone 3 from figure 2, that does not cross under the tracks.

TITLE TRACK MONITORING FOR WORK DISTURBING ROADBED	ORIGINAL ISSUE DATE 11/14/2019	NUMBER 2031
	REVISED DATE na	PAGE 4 OF 12

Determine the Zone of Influence for the underground crossing work at the elevation of the bottom of railroad tie. Calculate by taking the lowest elevation limits of the underground work, extending to the ground surface at the soil angle of repose. Soil angle of repose should be taken from soil borings performed at the crossing location that cover the depth from track level to the depth of underground work. If soil boring data is not available or does not satisfy the System Track COTR, use 20° as a conservative soil angle of repose. See Figure 4 for an example.

Any place the ZOI intersects Zone 2 from Figure 1 requires monitoring for the track directly perpendicular to the intersection of ZOI and Zone 2. In each direction, place RMPs every 15.5-feet until the RMP pairs are outside the Zone of Influence. Continue the RMPs for five pairs outside of the ZOI for a tie-in with undisturbed track. See Figure 5 for an example.

4. PRECONSTRUCTION ACTIVITIES

4.1. Track Monitoring Plan Submittal

Track Monitoring Plan shall be submitted a minimum of 4-weeks prior to commencement of roadbed disturbing work. The System Track COTR will review and provide comments or approval. As a minimum, the package must include the following:

- Information on the registration and experience of the field surveyor in charge performing the track monitoring.
- Design specifications of the total station instrument to be used, including angular accuracy and distance measurement accuracy.
- Design specifications of the prisms or targets to be used. Include information on adhesives, if used.
- Plan views, cross sections, profile views, or diagrams showing the roadbed disturbing work and the relation to the Zones shown in Figure 1. Include soil boring logs and laboratory data related to the project site.
- Detailed plan showing control locations in relationship to the tracks, roadbed disturbing work, and zone of influence. Include details on methods and frequency of control verification.
- Detailed Track Monitoring Plan view showing the location of all RMP locations, control points to be occupied during monitoring, the ground disturbing work and the ZOI. Each RMP must be numbered, with the hundredth being the track number, even numbered points on right rail, odd numbered points on left rail in the direction of increasing milepost. See Figure 6 for an Example Track Monitoring Plan.

4.2. Contractor Safety Training

All contractors that work on Amtrak owned or leased property are required to complete Amtrak's Contractor Orientation Training available at: www.amtrakcontractor.com

Contractor identification badges must be worn / displayed on the outermost garment, above the waist, always while on Amtrak owned or leased property.

TITLE TRACK MONITORING FOR WORK DISTURBING ROADBED	ORIGINAL ISSUE DATE 11/14/2019	NUMBER 2031
	REVISED DATE na	PAGE 5 OF 12

5. CONSTRUCTION

5.1. Track Inspector

Amtrak person having current qualifications in MW1000 and Physical Characteristics for the area work is being performed. Can inspect track and repair, restrict, or remove track from service if necessary.

Must be on-site when the leading end of work enters Zone 2 as shown on Figure 1 or as directed by the System Track COTR. Shall remain on-site until the completion of roadbed disturbing work, including reaming and pullback operations of horizontal directional drilling as defined by EP3005 Spec. 02082.

The Track Inspector will be provided at the sole cost of the project.

Will restrict or remove track from service if necessary, based on the MW1000 standards of track geometry for the class of track(s) involved. The Track Inspector has the authority to halt construction at any time should construction activities jeopardize the safe movement of trains over the work area.

5.2. Monitoring Procedures

Initial baseline reading of all monitoring points shall be recorded within ten (10) to five (5) days prior to construction. During the initial baseline readings, the offset from top of rail to the target shall be recorded for use in Track Monitoring Reports.

During construction, track monitoring shall start when the leading end of work enters Zone 2 as shown on Figure 2 or as directed by the System Track COTR. All RPMs shall be measured and recorded each time monitoring occurs.

Monitoring shall be performed at the beginning and end of every work shift, a minimum of twice daily (12-hour intervals). If track geometry meets or exceeds 0.03-feet (3/8-inch) of movement in any direction, monitoring must be performed every 4-hours until roadbed disturbing work is complete.

After roadbed disturbing work is complete, measurements will continue once a day until movement less than 0.01-feet (1/8-inch) has been observed for 5 consecutive days. Field conditions may warrant additional RMPs or extending the duration of post-construction monitoring as directed by the Track Inspector or System Track COTR.

5.3. Communication

Track Monitoring Report shall be produced immediately after each monitoring event. Measurements shown will be based on top-of-rail elevations based on the offset measured during initial setup. This will include total displacement of each RMP and cross level between RMP pairs.

Track Monitoring Reports must be signed and sealed by the surveyor in charge and cross-signed by the Track Inspector during work requiring their presence on-site. See Figure 6.7 for a sample Track Monitoring Report. The quickness of reporting track conditions is paramount to the safety of Amtrak operations.

An online sharing platform, such as Microsoft SharePoint Excel or Google Drive Sheets, must be set up and utilized by the contractor to immediately host the track monitoring data. A read-only link must be made available to the System Track COTR for distribution to Amtrak personnel as necessary. This real-time access will allow Amtrak's engineers to track movement and plan corrective action, if required.

TITLE TRACK MONITORING FOR WORK DISTURBING ROADBED	ORIGINAL ISSUE DATE 11/14/2019	NUMBER 2031
	REVISED DATE na	PAGE 6 OF 12

5.4. Remediation Procedures for Track Movement

- As a reminder: any person MW1000 qualified can restrict or remove a track from service based on track geometry conditions. Any person can stop the work and trains should construction activities jeopardize the safe movement of trains over the work area.

Deficiencies in track surface and alignment caused by construction activities shall be corrected solely by Amtrak forces.

If track is measured to have met or exceeds the track geometry maintenance limits as defined in the MW1000 for the class of track concerned or moves 0.03-feet (3/8-inch) displacement from baseline in any direction, then all work shall cease immediately. The following two items must be undertaken:

- The Track Inspector must immediately inspect the track geometry and take any corrective action that may be required per MW1000.
- The contractor must immediately and continuously attempt to notify the Amtrak Construction Project Manager, Assistant Division Engineer of Track, and System Track COTR of the deviations and confirm that corrective action is being taken on-site.

It is assumed that subsidence will continue, and corrective actions should be taken before track geometry exceeds the safety limits set forth in MW1000.

Any repairs made to correct track geometry will be made at the sole cost of the contractor.

5.5. Construction Re-Start

Work may not resume until the track inspector has inspected all tracks within the limits of disturbance and completed any appropriate action to repair, restrict, or remove the tracks from service. In addition, one of the following requirements must be met:

- If no further subsidence is expected, the Construction Manager must inspect the site and taken corrective action to ensure continued construction activities will not cause further track issues to the satisfaction of the System Track COTR.
- If further subsidence is expected, the Construction Manager, Assistant Division Engineer, and System Track COTR should agree on how to best protect train operations. Any further actions required to ensure the safe passage of trains, such as increased frequency of track monitoring, shall be at the sole expense of the contractor.

TITLE TRACK MONITORING FOR WORK DISTURBING ROADBED	ORIGINAL ISSUE DATE 11/14/2019	NUMBER 2031
	REVISED DATE na	PAGE 7 OF 12

6. FIGURES AND EXAMPLES

Figure 1, Zones of Influence under track (from Structures EP 3014)

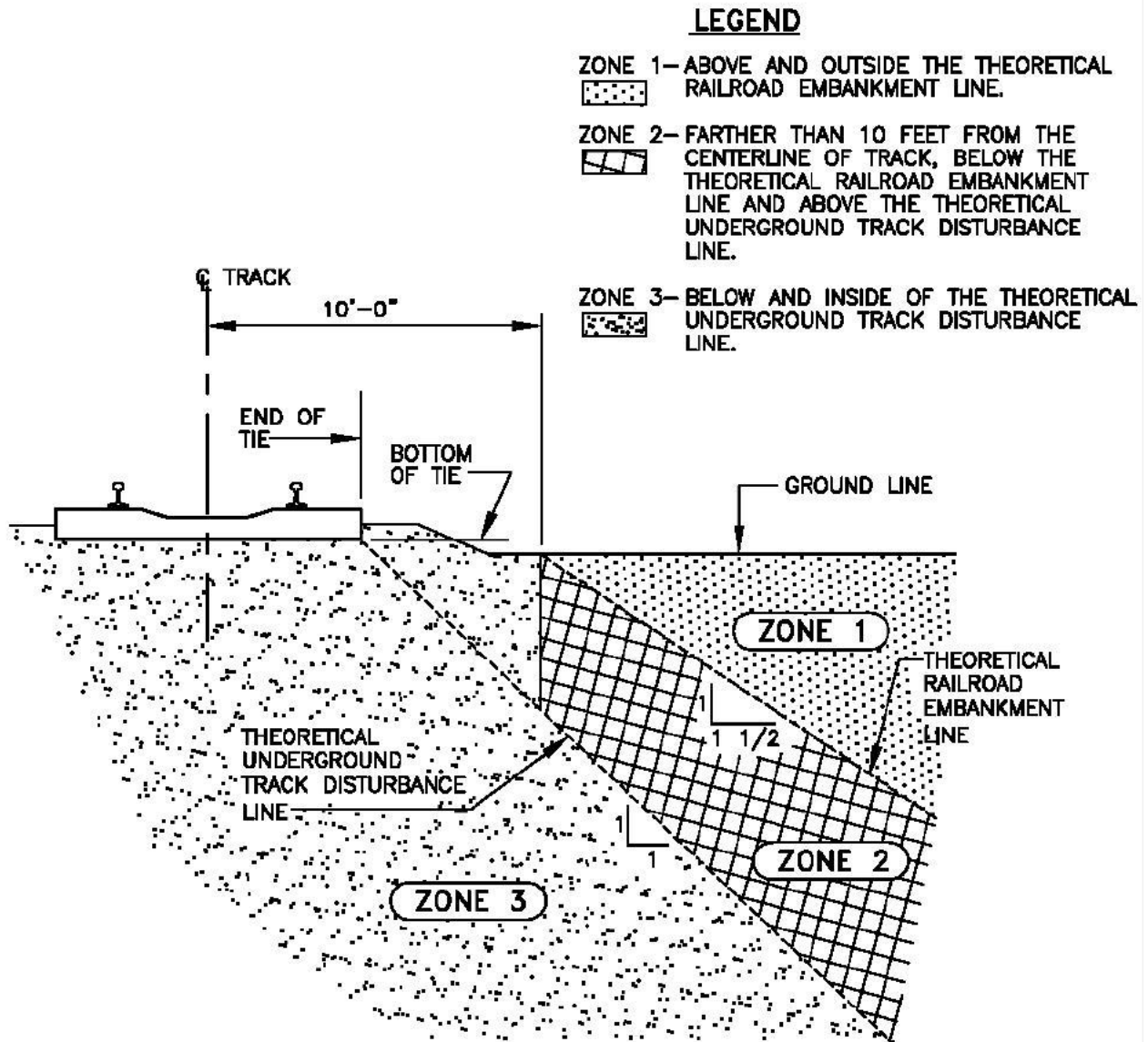

TITLE TRACK MONITORING FOR WORK DISTURBING ROADBED	ORIGINAL ISSUE DATE 11/14/2019	NUMBER 2031
	REVISED DATE na	PAGE 8 OF 12

Figure 2, Section View of Underground Crossing

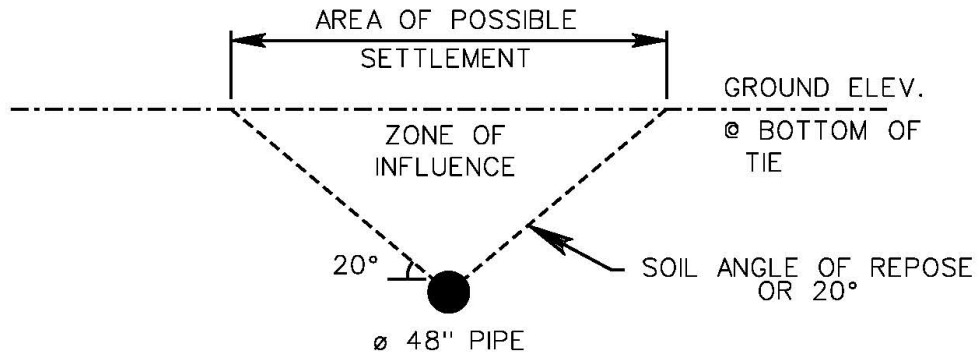
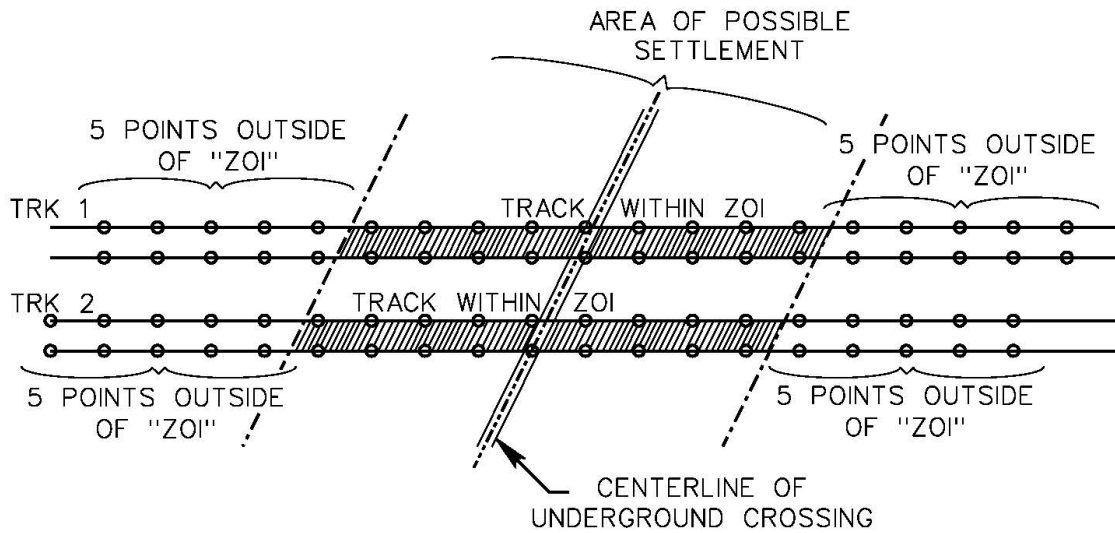

Figure 3, Plan View of Underground Crossing



TRACK MONITORING POINTS
SPACED 15.5 FEET ON BOTH RAILS

TITLE TRACK MONITORING FOR WORK DISTURBING ROADBED	ORIGINAL ISSUE DATE 11/14/2019	NUMBER 2031
	REVISED DATE na	PAGE 9 OF 12

Figure 4, Section View of Parallel Work

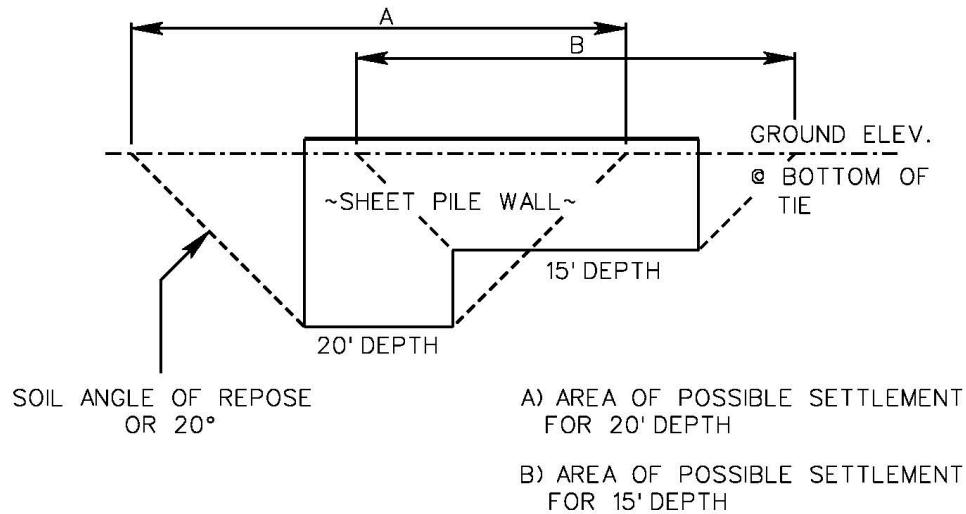
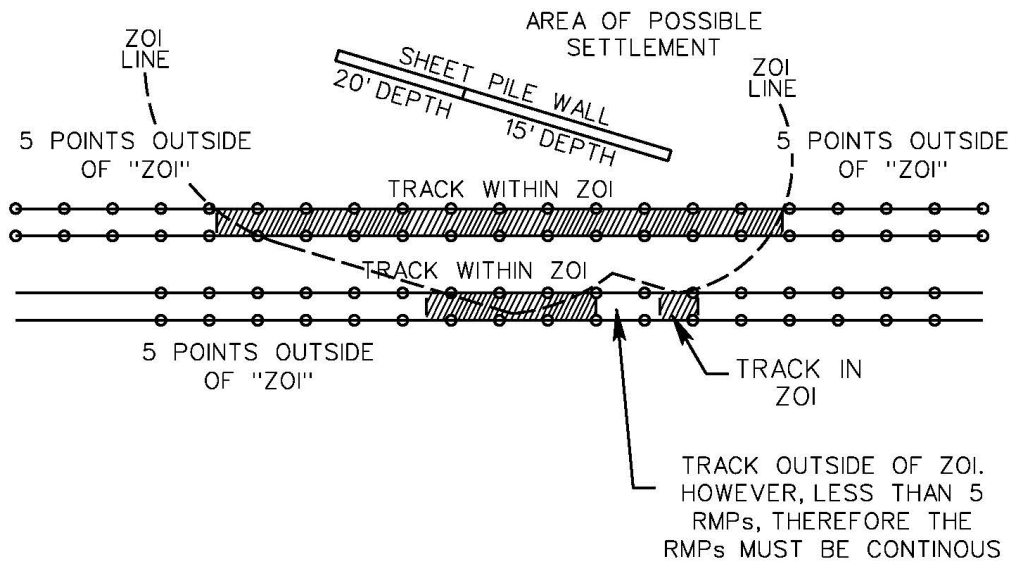
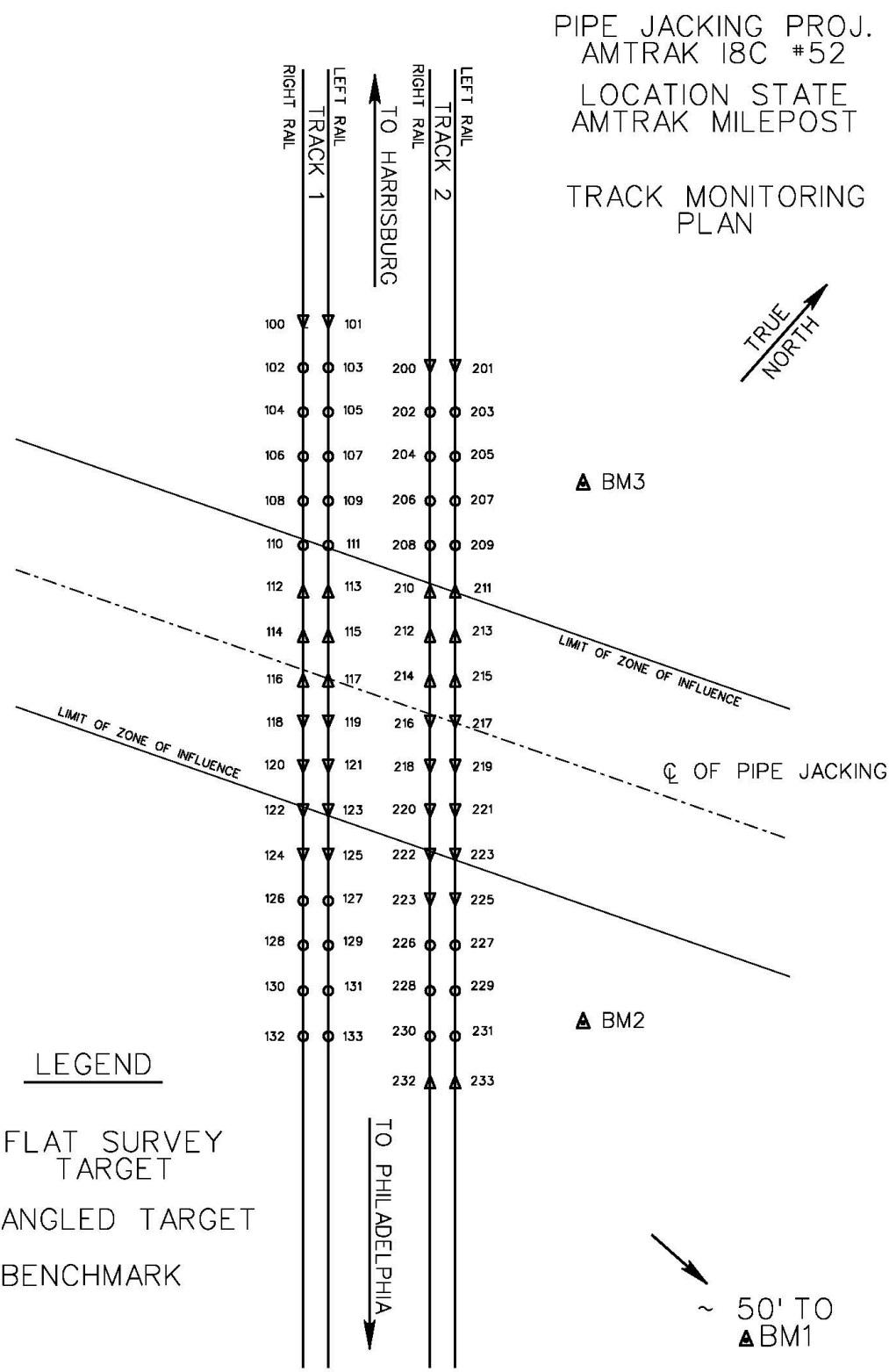

Figure 5, Plan View of Parallel Work



TITLE TRACK MONITORING FOR WORK DISTURBING ROADBED	ORIGINAL ISSUE DATE 11/14/2019	NUMBER 2031
	REVISED DATE na	PAGE 10 OF 12

Figure 6, Example Track Monitoring Plan



LEGEND

- FLAT SURVEY TARGET
- △ ANGLED TARGET
- ▲ BENCHMARK

TITLE TRACK MONITORING FOR WORK DISTURBING ROADBED	ORIGINAL ISSUE DATE 11/14/2019	NUMBER 2031
	REVISED DATE na	PAGE 11 OF 12

Figure 7, Example Track Monitoring Report

Monitoring Location: _____

Date & Time: _____

Underground Work Complete: _____ ft

Track Number for this Sheet: _____

Right Rail			Left Rail			Cross Level (inches)	
RPM	Top of Rail Movement (inches) (displacement from baseline)		RPM	Top of Rail Movement (inches) (displacement from baseline)			
	North	East		Elev	North		East
100				101			
102				103			
104				105			
106				107			
108				109			
110				111			
112				113			
114				115			
116				117			
118				119			
120				121			
122				123			

Land Surveyor signature: _____ Seal: _____

Track Inspector signature: _____

Track Inspector SAP number: _____

TITLE TRACK MONITORING FOR WORK DISTURBING ROADBED	ORIGINAL ISSUE DATE 11/14/2019	NUMBER 2031
	REVISED DATE na	PAGE 12 OF 12

Figure 8, Example Zone of Influence (Subsidence) Calculation

Scenario

Pipe jacking, perpendicular under tracks. 48-inch diameter pipe, 11-feet from top of rail elevation to top of pipe. No soil boring data given, assume Angle of Repose = 20°.

Calculations

Pipe Work \varnothing 48-inch = 4.00 ft
 Top of rail to bottom of tie 1.25 ft (typical)
 Bottom of tie to center of pipe depth top rail to top pipe – typical track depth + 1/2 Work
 11.00 ft – 1.25 ft + 2.00 ft = 7.75 ft

Half width of ZOI [depth * tan (angle of repose)] + 1/2 Work
 [(11.75 ft) tan (90° - 20°)] + 2.00 ft = 34.28 ft

Convert ZOI to stations 34.28 ft / 15.5 ft = 2.216 -(round)-> 2 stations

Determine total RMP pairs on each track

Center station (1) + Stations in ZOI, each direction (2 + 2) + Five tie-in stations (5 + 5) = Total

Total pairs of RMPs = 15 (centered on crossing)

